

LD800

Instruction manual

**Whole home dehumidifier,
ventilator and heat recovery unit**



Unique British design.

ECOR^{PRO}

THANK YOU

Dear Sir, Madam,

Congratulations on purchasing your ECOR PRO LD800.
A true investment and asset for any home.

In addition to dehumidification, the LD800 can provide fresh air to the living environment as well as keeping the energy in your home.
Even the power used in the LD800 is put back into the home.

Unique heat recovery system that will provide you with many years of energy saving in your home while protecting your home from the harmful affects of excess humidity such as dampness, condition & mould.

Keep you & your family healthier with fresh air & save money keeping expensive heat in your home with your ECOR PRO LD800.

Yours sincerely,

ECOR PRO
Customer Service Department



Before using your unit for the first time, please ensure that it has been standing for 2 hours in its upright position before it is plugged in.



Remove tie after installation.



Your unit helps to avoid:

- dampness
- condensation
- mould
- smells

Aiding other problems caused by "bad" air conditions:

- sickness
- headaches
- allergies

Your unit brings:

- DIY heat loss solution

GENERAL SAFETY

For safety reasons, please read this manual carefully before operating. Persons who are not familiar with this manual must not use this unit. We strongly recommend keeping this manual in a safe place for future reference.

This appliance is safe, however, as with other electrical appliances, use it with care. This appliance is not intended for use by persons (including children) with reduced physical, sensory or mental capabilities, or lack of experience and knowledge.

Warning! Never operate this appliance if it has a damaged cord or plug. If the supply cord is damaged, it must be replaced by an approved service representative or similar qualified person in order to avoid any hazards.

There should be direct access to the electrical plug after connecting the power!

Do not use your unit under the following conditions:

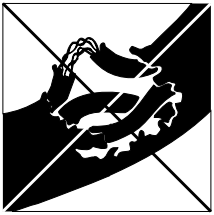

If the power cable wires are frayed or damaged

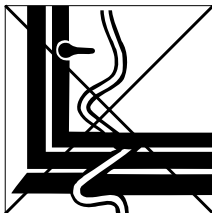

Where the power cable may be damaged

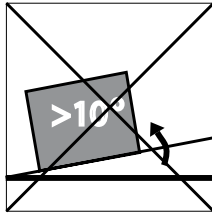

If the unit is placed unevenly

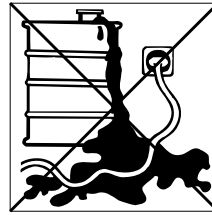

If the unit is, or can be in contact with chemicals

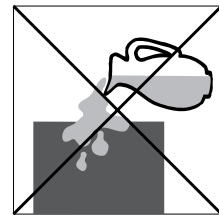

If there is a risk of liquid falling on the unit



If the unit is immersed with water



Close to a heat source

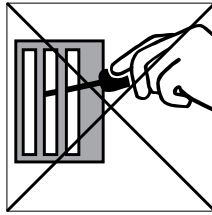

Where there is a risk of interference by foreign objects

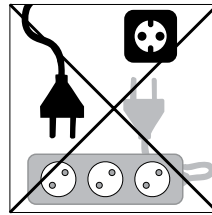

If an extension cord is needed to reach an outlet

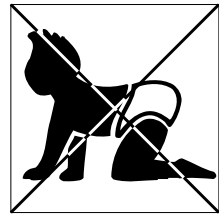

When small children may be left unattended



This appliance must be grounded and should only be connected to a grounded 230V ~/ 50 Hz main supply.



The installation must be in accordance with the regulations of the country where the unit is used.



The unit is designated for indoor operation only.

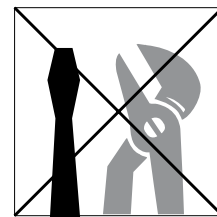

This product is not made for DIY repair

INSTALLATION - FOR INDOOR AREAS

Ideal for crawl spaces / home lofts
garages / warehouses / offices / whole home

Advantages

LD800 home dehumidifier, ventilator and heat recovery is 225% efficient at retaining heat from the home and introduction of fresh air.

Mechanical heat conserved and re-introduced into the home:

- Airflow 350 - 450 m³/h
 - Dehumidification up to 80 litres / day
 - Dehumidification at AHAM conditions up to 90 pints
 - Adjustable fresh air slider up to 100 m³/hr fresh air
- Pollen filter, easily changeable.
 - Can be included into an air ducting system.
 - Can be combined with a central air system.
 - One inlet and two outlets.
- All can be T-ducted to take air from multiple points or redeliver air to several points.
- Can run on fan only just to filter and circulate air in summer:
 - Fresh air inlet (150 mm).
 - Water drainage via side brass compression connector (19 mm).
- Top / Back or Top and Back exhausts (250 mm).
 - All metal construction and housing.
 - Useable ceiling hung in lofts.

Optional

- Optional controller to give on-off controls and regulate user-set environment.

Out of the box

You will find in the shipping carton:

- LD800 unit, complete with sealed wire and plug.
- 4 adjustable feet.
(Place the adjustable feet in the holes underneath the unit and set the unit level).
- Remove the tyrap (as indicated).

Check the rating plate, if the unit is made for the current you use.

Ecor Pro LD800: Whole Home Dehumidifier, Ventilator & Heat Recovery Unit



Remove tie after installation.



HOW IT WORKS

Your ECOR PRO LD800 dehumidifier controls the Relative Humidity by passing the air through the unit forcing the excess moisture to condensate over a cooling heat exchanger. This condensate water flows safely into a fixed drain.

The dried air then passes through a final heat exchanger where it is warmed before it re-enters the area at a slightly elevated temperature.

The level of dehumidifying is set with a digital humidistat control (not supplied). Ideal humidity is defined as being between 40-60% (Relative Humidity) on an average annual base.

40% RH - 60% RH

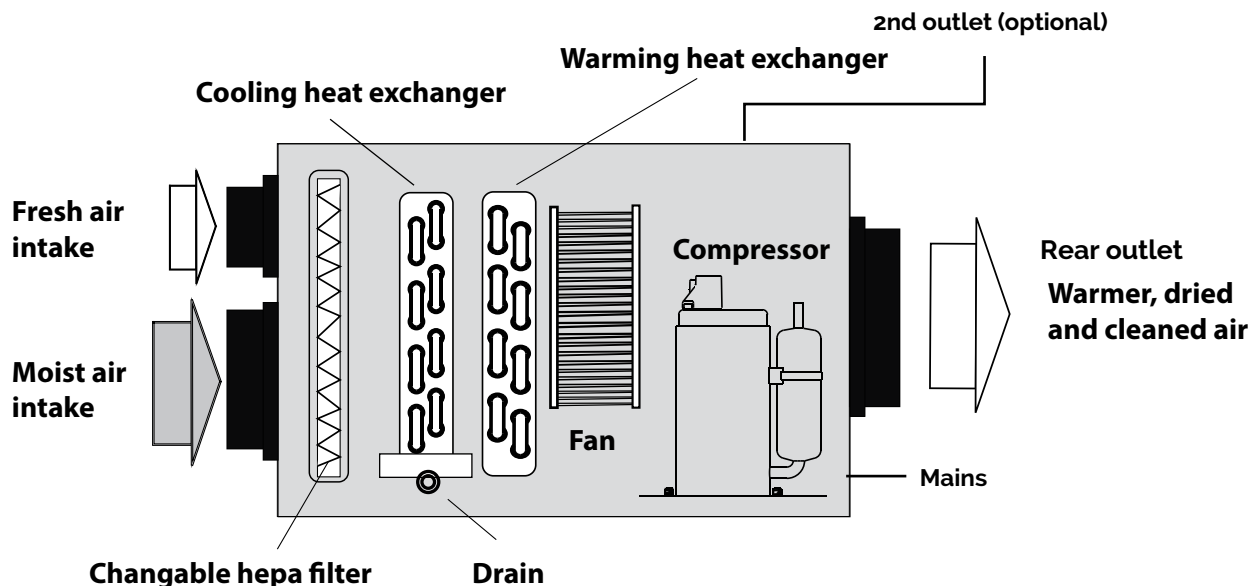

Points to consider before installation:

- **Fresh air Intake** (ø 150 mm)
- **Inlet moist air** (ø 250 mm)
- **Changeable air filter** – Filter must be placed
- **Drain** - Drainage tube connection point (female 3/4" - 19 mm)
- **Rear outlet** (ø 250 mm) - Warmer, dried and cleaner air
- **2nd outlet** (optional) - Easy to fit additional duct if desired
- **Connecting a controller** (optional) - see next page
- **Connecting to the mains** (refer to the rating plate)

For the most efficient use, outside doors and windows should be kept closed when the dehumidifier is operating.

POSITIONING YOUR LD800

WARNING

Before using the appliance it should be left in an upright position for at least 2 hours.

Your unit can be installed in any area with a relative humidity that is too high; such as a basement, play area, shed, archive room, swimming pool, boat, etc.

The unit will begin to protect from the harmful effects of excess moisture as soon it is installed and plugged in. The unit can stand on the floor or hung on a wall. When positioning your unit, ensure that it is placed level. Best results are obtained when windows and doors are closed, thus preventing the possible influx of fresh, too humid, air.



This appliance must be grounded and should only be connected to a grounded 230V ~/ 50 Hz main supply.



The installation must be in accordance with the regulations of the country where the unit is used.



The unit is designated for indoor operation only.

Connecting a controller (optional)

Optional controller to give on-off controls and regulate user-set environment. The controller is used to sense the conditions in the home. When the humidity gets beyond the user defined level, the LD800 will automatically start working. More complex controllers can be fitted to react to temperature and CO₂.



Remove the cover, two screws. Connect the controller as indicated.

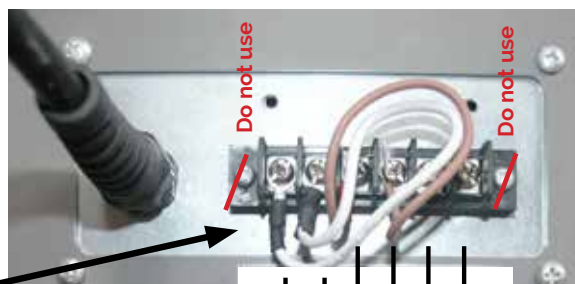

Low voltage terminal block. Used to connect optional controller.

A
FLOAT
B
DEHUM
COMPRESSOR & FAN
C
FAN

A For connecting to central air or heating controller

B To control dehumidification

C To control just the fan only and circulate air, but not dry th air



Transportation tie should be removed only after installation is complete. Do not forget!

Continuous drainage operation - side humidity

Drainage tube connection point. Excess water can be drained to the eaves, or suitable drain. If gravity drain is not possible, an additional pump should be fitted.

3/4" (19mm) female water outlet

Into drain at eaves or central drain system.



The pipe must be positioned so that there is a gradual downward slope from the connecting point to the drain.

Ensure that the outlet of the drainage pipe is not under the water level of the drain.

Note: In very cold weather conditions, precautions should be taken to prevent the drainage tube from freezing.

Fresh air Intake (∅ 150 mm)

Can take air from the loft space (which often has heat from the home and solar gain from roof tile sunlight absorption) or alternatively can be ducted to the outside through the roof (with suitable connection) or to the roof eaves, to draw fresh air in.

Fresh air regulator

Simple slider setting to allow the right amount of fresh air into the home - set by user.

Knob to loosen or fasten the slider

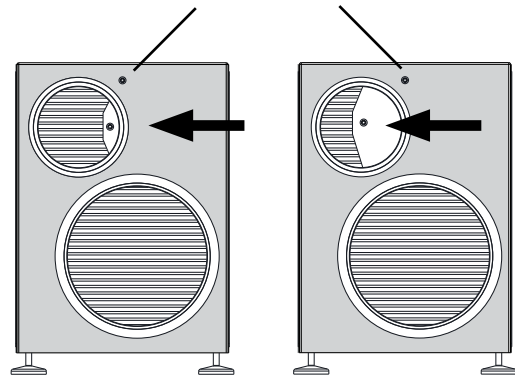

If the dehumidifier does not operate:

- Make sure the unit is plugged in.
- Ensure the controller (optional) is turned on.

If the unit is noisy:

- Make sure the dehumidifier is standing solidly and level.

If the unit is leaking:

- Check the drainage tube for correct fitting.
- Check for twists and bends in the drainage tube.
- Check the drainage tube for a sufficient slope.
- Check and make sure that the outlet of the drainage pipe is not under the water-level in the drain.

IMPORTANT:

This dehumidifier should not be used in temperatures below 5 °C or above 35 °C.

Installation - suitable for all indoor areas whether in the home, retail outlets, offices or other

Your unit can be installed in any area. Fresh, clean, dry air can be ducted as needed.

Damp air can be extracted where needed.

Can cope with a whole home if placed in a loft, basement or cupboard if ducted correctly.

Can even manage that air of a swimming pool environment (special coating permits).

A Fresh air Intake (ø 150 mm)– Can take air from the loft space (which often has heat from the home and solar gain from roof tile sunlight absorption) or alternatively, can be ducted to the outside through the roof (with suitable connection) or to the roof eaves to draw fresh air from outside.

Fresh air regulator – Simple slider setting to allow the right amount of fresh air into the home set by user.

B Inlet moist air (ø 250 mm) – Can have single or multiple inlets by using Y or T connectors to the inlet pipe connected to other rooms to draw air from typically the bedrooms into the unit.

C Rear outlet. (ø 250 mm)- Often ducted to central location in the home such as landing.

2nd outlet (optional)– Easy to fit additional duct to the living area (on top of the unit).

Side humidity - Drainage tub connection point. Excess water can be drained to the eaves, or suitable drain. If gravity drain not possible an additional pump should be fitted.

Controller (optional) - A controller is used to sense the conditions in the home. When the humidity gets beyond the user defined level the LD800 will automatically start working. More complex Controllers can be fitted to react to temperature and CO₂.

Changeable filter – Filters the air before heat is extracted and circulated back into the home, helping allergy sufferer.

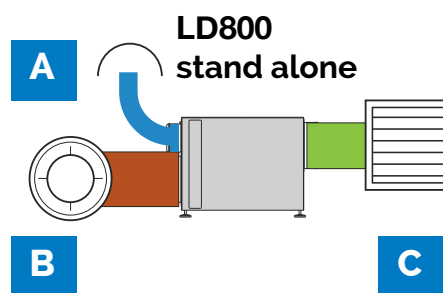

LD800 included in a ducted system

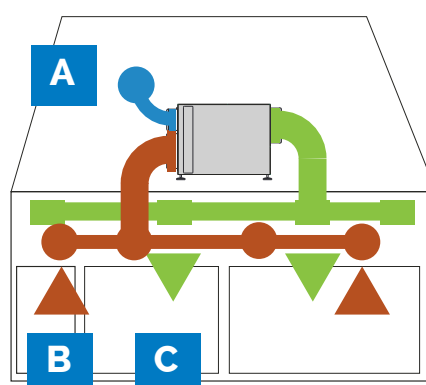

Top view

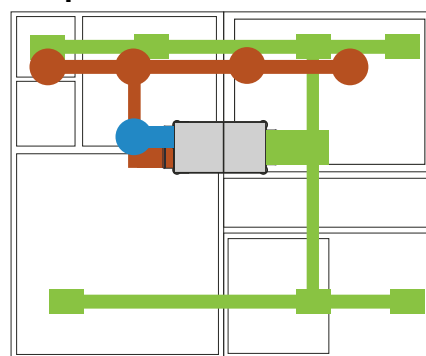

LD800 can be incorporated in a central air system

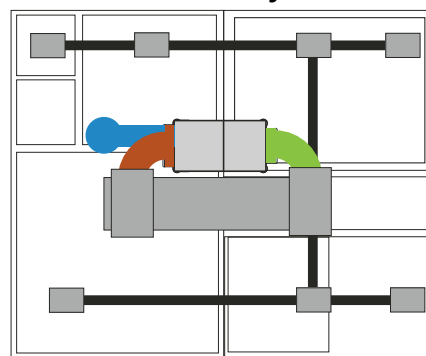

CLEANING

Disconnect from the mains before cleaning or servicing the unit or any of its components.

Housing (all metal housing)

Wipe regularly clean with a moist cloth (a soft, damp cloth) and a mild household detergent. Never use aggressive chemicals, petrol, aggressive detergents or other cleansing solutions.

Air filter (HEPA type)

Remove for periodic replacement, helping to reduce the need to dust and helping against bacteria, helping to prevent allergies.

Air circulation is impeded and the efficiency of the dehumidifying and air purifying functions decreases when the filter is dirty. It is therefore good practice to replace the filter at regular intervals. The precise intervals depend on the room in which the appliance operates and on how frequently it is used. Replace the filter at least once a year. If you do not replace the filter in time, the unit gets dirty inside and the dirt may cause damage.

Caution



This unit should not be operated without the air filter fitted. Operation without the air filter may damage the heat exchangers.

Servicing

Have your unit once a year serviced by a qualified engineer.

How to place a new filter :

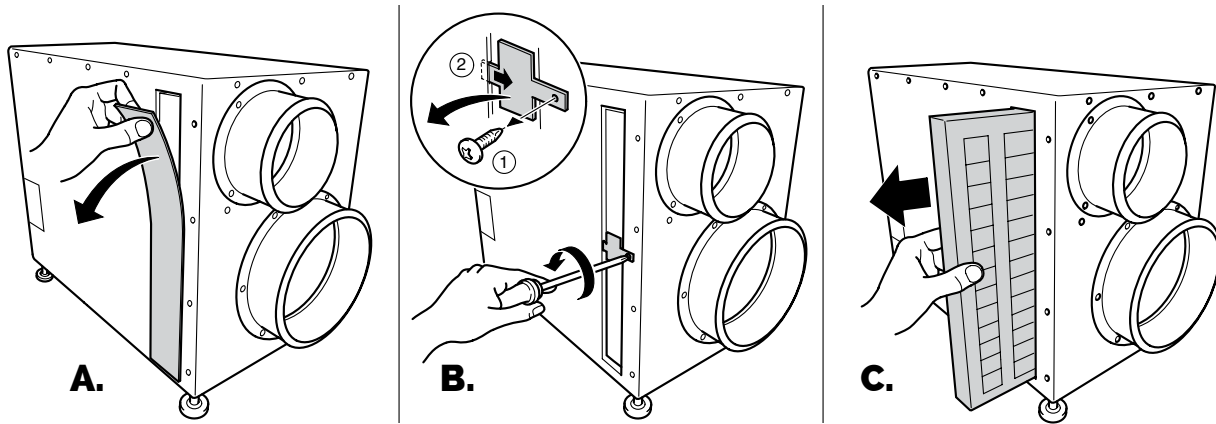

A.

B.

C.



- A. Remove the magnetic seal (filter access door) on one of the two sides.
- B. Remove the small metal plate by loosening the screw.
- C. Slide the filter out of the unit.

Place the new filter (C).

Replace the small metal plate (B) with the screw.

Replace the magnetic seal (A) carefully to cover the door.

TECHNICAL DATA

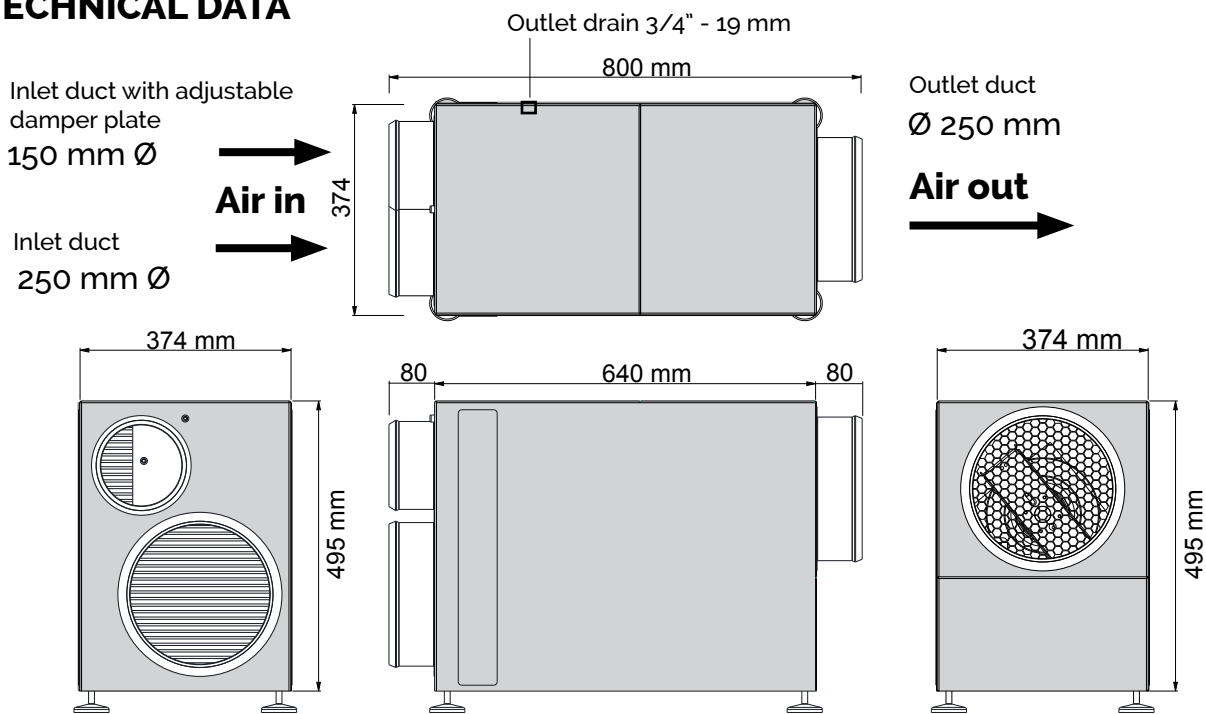

Dehumidifier, Ventilator & Heat recovery Unit	LD800 Model D005A-80L
Rated voltage	230V ~
Rated frequency	50 Hz
Rated input	890 W
Rated current	4.0 A
Resistance Class	IP20
Air flow	350-450 m ³ /h
Rated dehumidifying capacity	80 l/day (30°C - RH 80%)
Applicable temperature	5-35 °C
Refrigerant / Weight	Environmentally friendly R410A / 660 g
Max. allowable pressure	Discharge 5.0 MPA Suction 1.2 MPA
Dimensions (mm)	
Length	800 (640)
Width	374
Height	495
Weight	36 kg

Low Voltage Directive 2014/35/EU - EMC Directive 2014/30/EU
Specifications may change without prior notice.

WIRING DIAGRAM - LD800

220-240 V / AC • 50 HZ • SINGLE PHASE

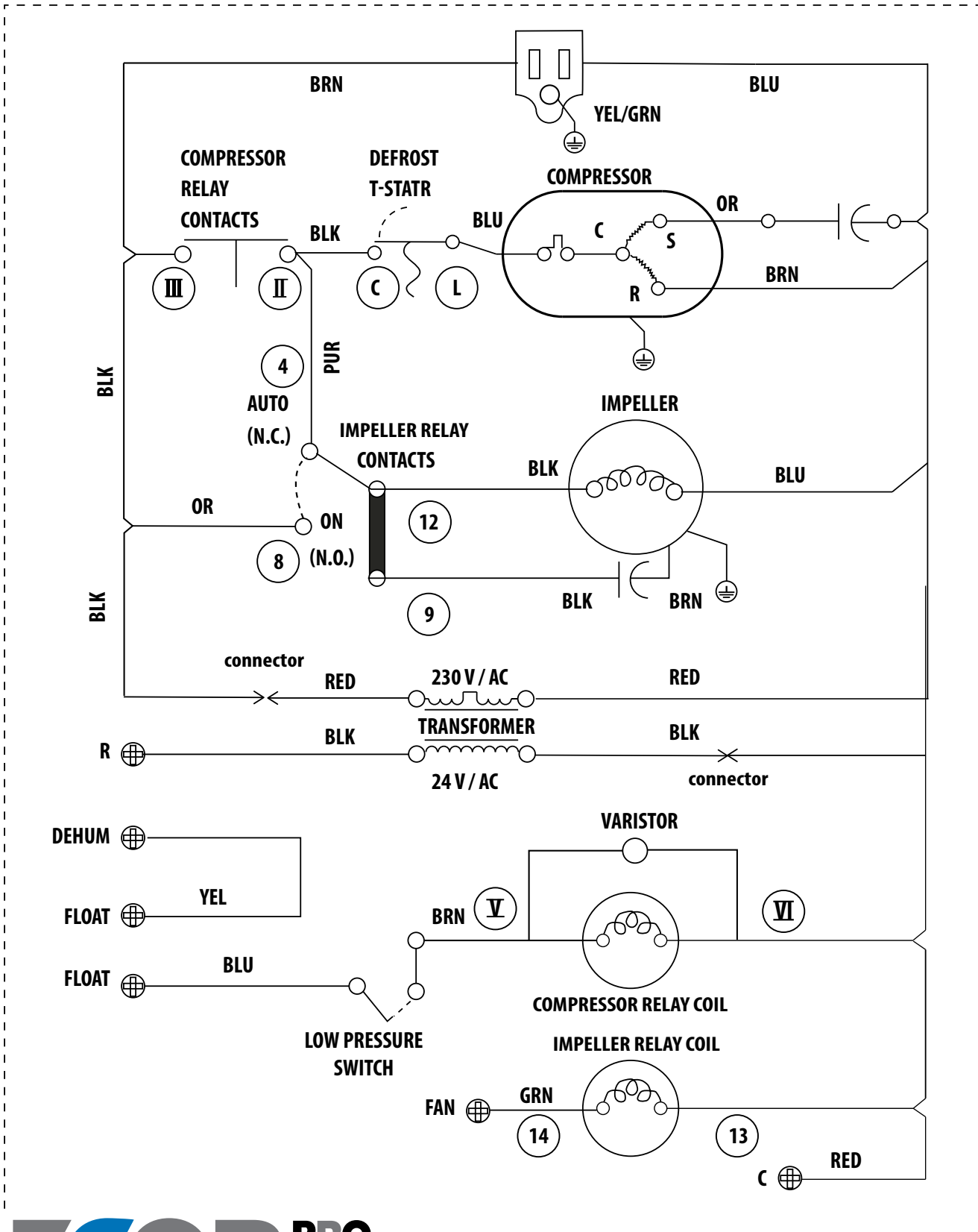

GUARANTEE CONDITIONS

The LD800 is supplied with a 24-month guarantee, commencing on the date of purchase.

All material and manufacturing defects will be repaired or replaced free of charge within this period.

The following rules apply:

We expressly refute all further damage claims, including claims for collateral damage.

Repairs to or replacement of components within the guarantee period will not result in an extension of the guarantee.

The guarantee is invalidated if any modifications have been made, non genuine parts are fitted or repairs are carried out by third parties.

Components subject to normal wear, such as the filter, are not covered by the guarantee.

The guarantee is valid only when you present the original, dated purchase invoice and if no modifications have been made.

Disposal



Waste electrical and electronic products must not be disposed of with household waste. This product should be taken to your local recycling centre for safe treatment.



ECOR PRO

Anton Philipsweg 9-11
1422 AL UITHOORN
The Netherlands

Tel.: +31 (0)297 52 75 83
Fax: +31 (0)297 56 01 87

info@ecorproducts.com
www.ecorproducts.com

Chamber of Commerce: 34334850



Subject to modifications. / Änderungen vorbehalten.
Sous réserve de modifications. / Wijzigingen voorbehouden.